

Article number: 03552080

Description: Fluro hydraulic rod end FPR 80N

Measures

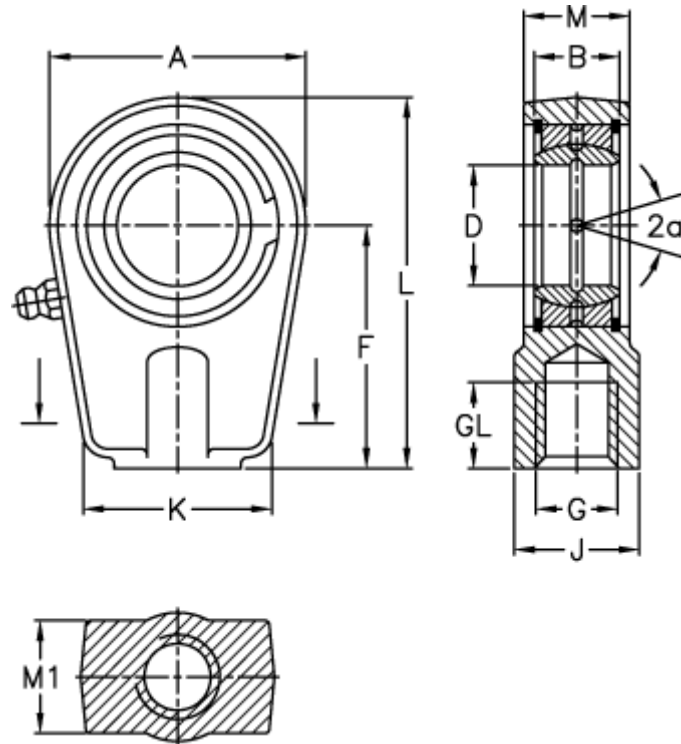

A	= 176	J	= 105
a (degrees)	= 6	K	= 160
B	= 55	L	= 265
D	= 80	M	= 60
Dynamic load C (kN)	= 400	M1	= 55
F	= 170	Static load C0 (kN)	= 670
g	= M80x2	Weight	= 13200
GL	= 81		